



Rechargeable LiFePO4 Battery
LP1900 Series
User Manual

please read this manual before installing the battery, and follow the instructions carefully during the installation process. If you have any doubts, please contact your seller for assistance immediately.

- 1. Safety Instructions.....1**
- 1.1 Before connecting.....2
- 1.2 In Using.....2
- 2. Introduction.....3**
- 2.1 Product Features.....3
- 2.2 Product Specification.....4
- 2.3 Equipment interface instruction.....5
- 2.4 Battery cables terminal.....10
- 2.5 LED Status Showing.....11
- 2.6 BMS basic function.....11
- 3. Safe handling Guide of Lithium Battery.....12**
- 3.1 Schematic diagram of solution.....12
- 3.2 Danger Label.....12
- 3.3 Tools.....12
- 3.4 Safety gear.....13
- 4. Installation and Operation.....13**
- 4.1 Package Items.....13
- 4.2 Installation Location.....14
- 4.3 Grounding.....15
- 4.4 Put into cabinet or racks.....15
- 4.5 Power on.....16
- 4.6 Power off.....17
- 4.7 Multi-group mode.....17
- 5. Trouble shooting.....18**
- 6. Emergency Situations.....20**
- 7. Remarks.....21**

1. Safety Precautions



Reminding

- 1) Before installing or using the battery, it is important and necessary to read the user manual carefully. Failure to do so or to follow any instructions or warnings in this document may result in electric shock, serious injury or death, or may damage the battery, potentially rendering it inoperable.
- 2) If the battery is stored for long time, it is required to charge them every six months, and the SOC should be no less than 90%.
- 3) The battery needs to be charged within 12 hours, after full discharge.
- 4) Do not install the product in an outdoor environment, or an environment beyond the operating temperature or humidity range listed in the manual.
- 5) Do not expose the cable to the outside.
- 6) Do not connect power terminal reversely.
- 7) All battery terminals must be disconnected for maintenance.
- 8) Please contact the supplier within 24 hours if there is something abnormal.
- 9) Do not use detergent to clean the battery.
- 10) Do not expose batteries to flammable or harsh chemicals or vapors.
- 11) Do not paint any part of the battery, including any internal or external components.
- 12) Do not connect battery with PV solar wiring directly.
- 13) The warranty claims are excluded for direct or indirect damage due to items above.
- 14) Any foreign object is prohibited to insert into any part of battery.



Li-ion





Warning

1.1 Before connecting

- 1) After unpacking, please check the product and packing list first, if the product is damaged or missing parts, please contact your local dealer seller contact.
- 2) Before installation, be sure to cut off the grid power and make sure the battery is in the turned-off mode.
- 3) Wiring must be correct, do not mistake the positive and negative cables, and ensure no short circuit with the external device.
- 4) It is forbidden to directly connect the battery and AC power.
- 5) The battery embedded BMS is designed for single battery voltage, please do not connect the battery in series.
- 6) The battery must be grounded and the resistance must be less than 0.1Ω .
- 7) Please ensure that the electrical parameters of the battery system are compatible with related equipment.
- 8) Keep the battery away from water and fire.

1.2 In using

- 1) If you need to move or repair the battery system, you must cut off the power supply and turn off the battery completely.
- 2) It is forbidden to connect the battery with different types of batteries.
- 3) It is forbidden to connect the battery with a faulty or incompatible inverter.
- 4) It is forbidden to disassemble the battery (the QC label falls off or is damaged).
- 5) In the event of a fire, only dry powder fire extinguishers can be used, and liquid fire extinguishers are prohibited.
- 6) Please do not open, repair or disassemble the battery except staffs from your seller or authorized by your seller. We do not undertake any consequences or related responsibility which because of violation of safety operation or violating of design, production and equipment safety standards.

2. Introduction

LP1900 series lithium iron phosphate battery is a new energy storage product , which can provide reliable power support for various equipment and systems.

The LP1900 series has a built-in BMS battery management system, which can manage and monitor battery voltage, current, temperature and other information.

2.1 Product Features

- 1) Built-in soft start function, when the inverter needs to start from the battery, it can reduce the current impact.
- 2) Double active protection at BMS level.
- 3) Automatically set the address when multiple groups are connected.
- 4) Support wake-up via 5~12V signal of RJ45 port.
- 5) Support the host controller to upgrade the battery module through CAN or RS485 communication.
- 6) Enable 95% depth of discharge, which can be used for inverters operating in full compliance with its protocol.
- 7) The module is non-toxic, non-polluting and environmentally friendly.
- 8) The cathode material is lithium iron phosphate, which has good safety performance and long cycle life.
- 9) The battery management system (BMS) has protection functions such as over-discharge, over-charge, over-current, high and low temperature, etc.
- 10) The system can automatically manage the charging and discharging status and balance the voltage of each cell.
- 11) Flexible configuration, multiple battery modules can be connected in parallel to expand capacity and power.
- 12) Adopt self-cooling method to quickly reduce the overall noise of the system.
- 13) The module has less self-discharge, and can be put on the shelf for up to 6 months without charging. There is no memory effect, and the shallow charge and discharge performance is excellent.
- 14) Small size, light weight, easy installation and maintenance.

2.2 Product Specification

(1) Battery Technical specification

parameter	Data sheet		
nominal voltage	12.8V	25.6V	51.2V
Discharge voltage	10.8-14.6V	21.6-29.2V	43.2-58.4V
Charging voltage	14.6V	29.2V	58.4V
Recommended charging	0.5C		
Max charging current	1C		
Recommended discharging current	0.5C		
Max discharging current	1C		
Communication	RS485/RS232/CAN		
depth of discharge	95%		
Working Temperature	0°C ~ 50°C Charge		
	-10°C ~ 50°C Discharge		
The shelf temperature	-20°C ~ 60°C		
Protection degree	I		
IP degree	IP 54		
Humidity	5 ~ 95%(RH)		
elevation	< 4000		
Certificates	CE/UN38.3/MSDS		
Design life cycle	10+Years (25°C/77°F)		
Cycles	> 4500 at 25°C		

2.3 Equipment interface instruction

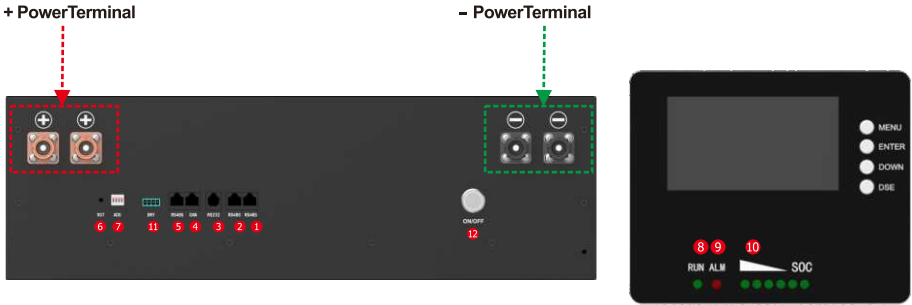

12 Function Switch

- (1) ON: starting
- (2) OFF: Power off for storage or transportation

8 RUN

- (1) Green LED light shows battery running status

9 ALM

- (2) Red LED flashing indicates battery alarm; On: The battery is protected

10 SOC

- (1) Six green LED show the current capacity of the battery

6 RST

- (1) Long press for more than 0.5s to start the battery
- (2) Long press for more than 5 seconds to turn off the battery

7 ADDS: DIP switch setting instructions

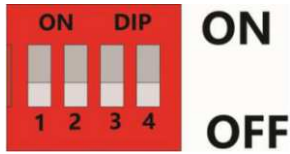

DIP switch diagram (SW1 connector)

Address	DIP switch position			
	#1	#2	#3	#4
0	OFF	OFF	OFF	OFF
1	ON	OFF	OFF	OFF
2	OFF	ON	OFF	OFF
3	ON	ON	OFF	OFF
4	OFF	OFF	ON	OFF
5	ON	OFF	ON	OFF
6	OFF	ON	ON	OFF
7	ON	ON	ON	OFF
8	OFF	OFF	OFF	ON
9	ON	OFF	OFF	ON
10	OFF	ON	OFF	ON
11	ON	ON	OFF	ON
12	OFF	OFF	ON	ON
13	ON	OFF	ON	ON
14	OFF	ON	ON	ON
15	ON	ON	ON	ON

(1) Single battery set using dial code:



Single battery set using dial code

(2) Multiple sets of batteries in parallel use the DIP settings:

Multiple sets of batteries in parallel use the DIP

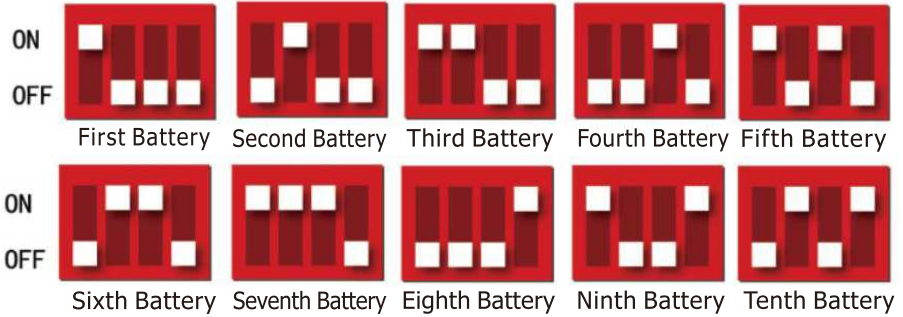

10 Dry contact output description :



1 2 3 4

(1) Dry contact 1-PIN1 to PIN2: normally open, low battery closed

(2) Dry contact 2-PIN3 to PIN4: normally open, closed during fault protection

1 2 5 RS485: For Connecting with inverter and slave battery

(1) 485 communication port definition:

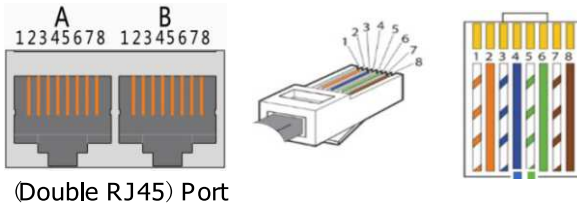

Port	Definition		Definition			
485 communication port definition	A Part RS-485-2port	PIN 1	RS485-B2	B Part RS-485-2 Port	PIN 1	RS485-B2
		PIN 2	RS485-A2		PIN 2	RS485-A2
		PIN 3	RS485-GND		PIN 3	RS485-GND
		PIN 4	NC(Empty)		PIN 4	NC(Empty)
		PIN 5	NC(Empty)		PIN 5	NC(Empty)
		PIN 6	RS485-GND		PIN 6	RS485-GND
		PIN 7	RS485-A2		PIN 7	RS485-A2
		PIN 8	RS485-B2		PIN 8	RS485-B2

(2) RS485 Battery Pack Parallel Function :

1. Under parallel status, Communication address 0001 is Master battery pack, rest communication position are slave battery. And slave battery could communication with master battery pack through RS485 port. master battery pack will collect all slave battery data.

2. When parallel status, only master battery pack communicate with PC upper computer as remote monitoring, uploading datas, displaying status & any other info of all battery packs.

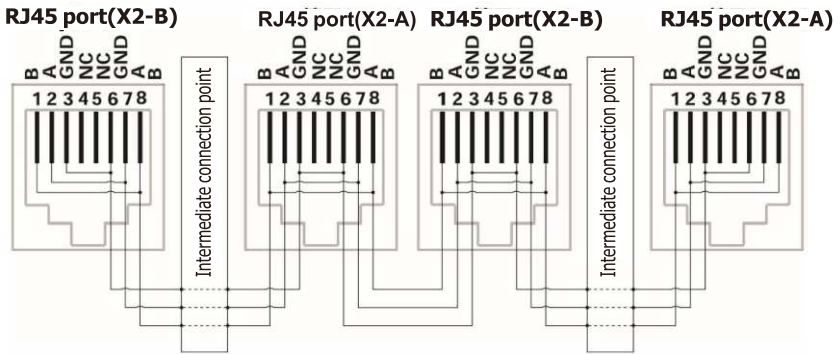
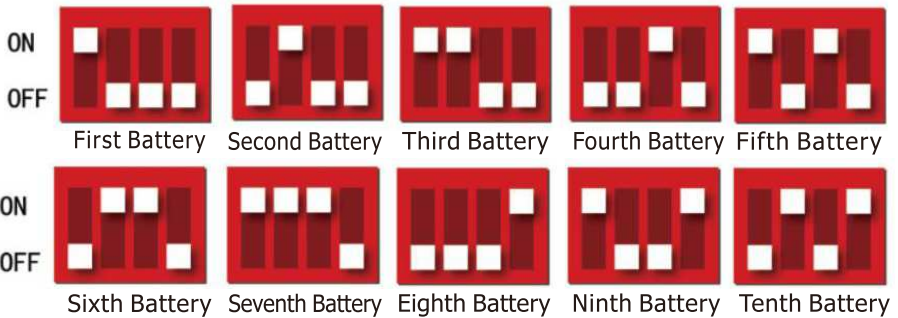

Diagram RS485 Parallel Cables Connection

Processing several pack parallel communication, need to set the single pack DIP firstly, and take BCD format as follows.

Multiple sets of batteries in parallel use the DIP



- 3 RS232 (Adjusting): RS232 connecting with upper computer to let manufacturer or professional engineer to process adjusting service
- (1) RS232 Communication Port Definition

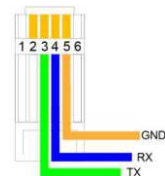
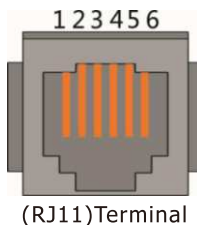

Port	Clarifying	
RS232 Communication port Difinition	PIN 1	NC(Empty)
	PIN 2	NC(Empty)
	PIN 3	TX protection board sending data (PC receiving data)
	PIN 4	RX protection board receiving data (PC Sending data)
	PIN 5	GND
	PIN 6	NC(Empty)

4 CAN : Usage to connecting with inverter or master battery pack

(1)CAN communication port difinition

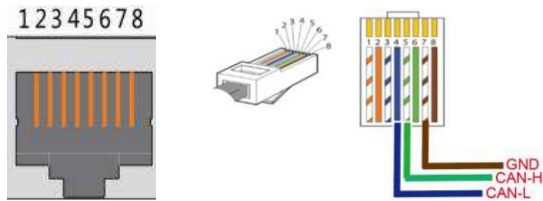

(Double RJ45) terminals

Port	Difinition	
CAN communication port difinition	PIN 1	NC(Empty)
	PIN 2	NC(Empty)
	PIN 3	NC(Empty)
	PIN 4	CANL
	PIN 5	CANH
	PIN 6	NC(Empty)
	PIN 7	GND
	PIN 8	NC(Empty)



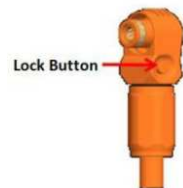

2.4 Battery cables terminal

Same function terminal , for connection facility. For power cables uses water-proofed connectors. MUST keep pressing this Lock Button while pulling out the power plug.





2.5 LED Status Showing

Condition	RUN	ALR	1	2	3	4	5	6
OFF	–	–	–	–	–	–	–	–
ON	●	●	●	●	●	●	●	●
NORMAL	■	–	–	–	–	–	–	–
Charge	●	–	Show soc					
Discharge	■	–	Show soc					
Alarm	ALM  Other LEDs are same as above.							
System fault or protection	–	●	–	–	–	–	–	–
	ON							
	flash, on: 0.3s; off: 3.7s							
	flash, on:0.5s; off: 1.5s							

2.6 BMS basic function

Protection and alarm	Management and monitor
Charge/Discharge End	Cells Balance
Charge Over Voltage	Intelligent Charge Model
Discharge Under Voltage	Charge/Discharge Current Limit
Charge/Discharge Over Current	Capacity Retention Calculate
High/Low Temperature(cell/BMS)	Administrator Monitor
Short Circuit	Operation Record
	Power Cable Reverse
	Soft start of inverter

3. Safe handling Guide of Lithium Battery

3.1 Schematic diagram of solution

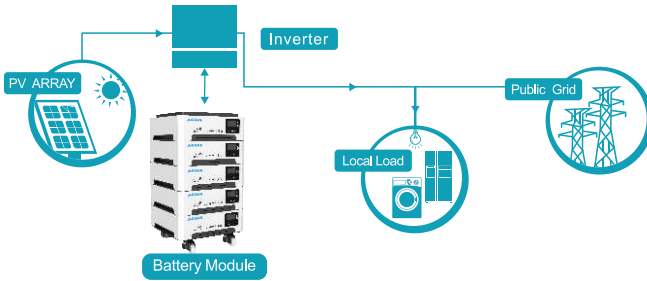

3.2 Danger Label

DANGER
DANGER LOW DC VOLTAGE INSIDE
DANGER ARC FLASH & SHOCK HAZARD

- Do not disconnect or disassemble by non-professional personnel.
- Do not drop, deform, impact, cut or spearing with a sharp object.
- Do not place at a children or pet touchable area.
- Do not place near open flame or flammable material.
- Do not cover or wrap the product case.
- Do not sit or put heavy things on battery.
- Do not touch the leaking liquid.
- Avoid of direct sunlight.
- Avoid of moisture or liquid.
- The product Ingress Protection (IP) class is IP20.
- Make sure the grounding connection set correctly before operation.
- Follow the product manual to make wiring connection.
- If leaking, fire, wet or damaged, switch off the breaker on DC side and stay away from battery.
- Contact your supplier within 24 hours if anything failure happens.

3.3 Tools



Wire cutter



Crimping modular plier



Screwdriver

NOTE

Use properly insulated tools to prevent accidental electric shock or short circuits. If insulated tools are not available, cover the entire exposed metal surfaces of the available tools, except their tips, with electrical tape.

3.4 Safety gear

It is recommended to wear the following safety gear when dealing with the battery pack.



Insulated gloves



Safety goggles



Safety shoes

4. Installation and Operation

4.1 Package Items

Unpack and check the packing list

(1) For battery module package :

- ① Single battery pack standard package: 1pc orange and black waterproof terminal and OT(100A)



③ Could be customization per require: battery cable、 communication cable、 parallel cable、 grounding cable.

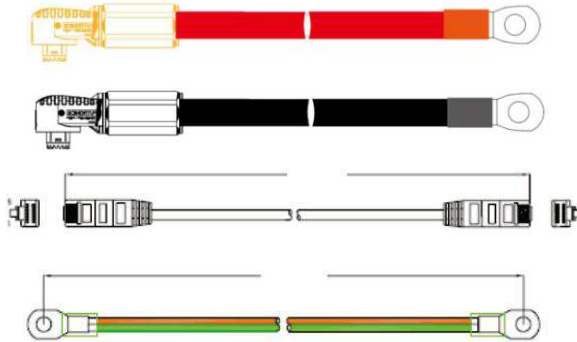

(2) For battery system connecting to inverters:

Two long power cables (current capacity 120A, constant 100A) and one communication cable for each energy storage system:

4.2 Installation Location

Make sure that the installation location meets the following conditions:

- (1) The area is completely water proof.
- (2) The floor is flat and level.
- (3) There are no flammable or explosive materials.
- (4) The ambient temperature is within the range from 0°C to 50°C.
- (5) The temperature and humidity is maintained at a constant level.
- (6) There is minimal dust and dirt in the area.
- (7) The distance from heat source is more than 2 meters
- (8) The distance from air outlet of inverter is more than 0.5 meters.
- (9) The installation area shall avoid of direct sunlight.
- (10) There is no mandatory ventilation requirements for battery module, but please avoid of installation in confined area. The aeration shall avoid of high salinity, humidity or temperature.



Caution

If the ambient temperature is outside the operating range, the battery pack stops operating to protect itself. The optimal temperature range for the battery pack to operate is 0°C to 50°C. Frequent exposure to harsh temperatures may deteriorate the performance and life of the battery pack.

4.3 Grounding

Grounding cables shall be 10AWG or higher yellow-green cables. After connection, the resistance from battery grounding point to Ground connection point of room or installed place shall smaller than 0.1Ω .

Install a grounding cable to the grounding point of the modules.

4.4 Installation Instruction

- (1) Connect the cables to inverter.
- (2) Connect the cables between battery modules.

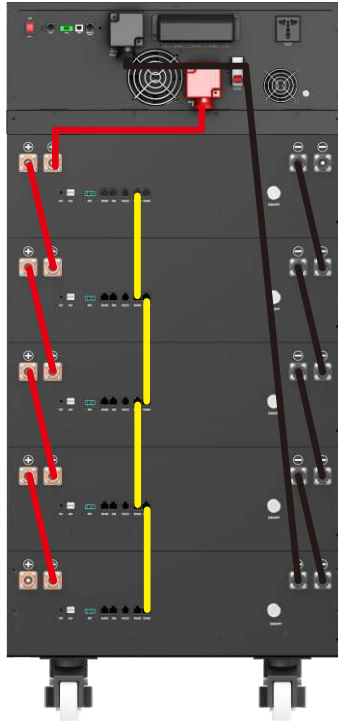

Caution

- (1) A suitable breaker between battery system and inverter is required.
- (2) All the installation and operation must follow local electric standard.

4.5 Power on

Double check all the power cable and communication cable.

(1) Switch on all the battery modules:



(2) The one with empty Link Port 1 is the Master Battery Module, others are slaves (1 master battery configure with maximum 15 slave batteries):

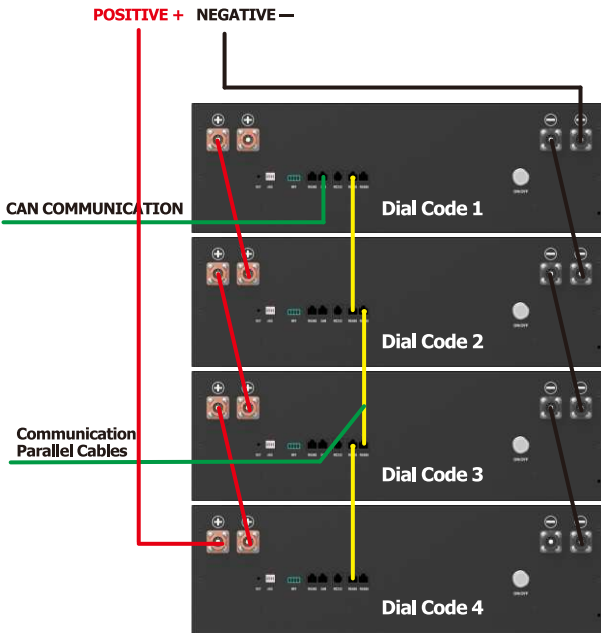

(3) Press the red SW button of master battery to power on, all the battery LED light will be on one by one from the Master battery.

Note:

- (1) After the battery module powered on, the soft-start function takes 3sec to active. After soft-starts battery ready to output high power.
- (2) During capacity expansion or replacement, when parallel different SOC/voltage of module together, please maintain the system in idle for ≥ 15 mins or till the SOC LED becomes similarly (≤ 1 dot difference) before normal operation.

4.6 Power off

- (1) Turn external power source off.
- (2) Press red SW switch of master battery. Then all batteries will off.
- (3) Turn off the power switch .

4.7 Multi-group mode

Connect power cable first:

- (1) each pair of cable hold max 100A constant current. Connect enough pairs of cable based on calculation of system current.
- (2) Suitable protection breaker between battery system and inverter is required.
- (3) Make sure all dip switch of master batteries are R 0XX, then turn ON batteries.
R: is the baud rate of RS485 needed, all master batteries shall be the same.
- (4) After all batteries running and buzzer of master battery in group1 rings 3 times. Means all groups are online.

The interruption of each RS485 command shall at least ≥ 1 s.

5.Trouble shooting

Problem determination based on:

- (1) Whether the battery can be turned on or not.
- (2) If battery is turned on, check the red light is off, flashing or lighting.
- (3) If the red light is off, check whether the battery can be charged/discharged or not.

Possible conditions:

- (1) Battery cannot turn on, switch ON and press the metal SW the lights are all no lighting or flashing.

- (1.1) Capacity too low, or module over discharged.

solution: use a charge or inverter to charge battery. If battery can start, then keep charge the module and use monitor tools to check the battery log.

If battery terminal voltage is $\leq 2.8V/\text{cell}$, please use $\leq 0.05C$ to slowly charge the module to avoid affect to SOH.

If battery terminal voltage is $> 2.8V/\text{cell}$, it can use $\leq 0.5C$ to charge.

If battery cannot start, turn off battery and repair.

- (2)The battery can turn on, but red light is lighting, and cannot charge or discharge. If the red light is lighting, that means system is abnormal, please check values as following.

- (2.1)Temperature: Above 60°C or under -10°C , the battery could not work.

Solution: to move battery to the normal operating temperature range between 0°C and 50°C .

- (2.2)Current: If current exceeds $100A$, battery protection will turn on.

Solution: Check whether current is too large or not, if it is, change the settings on power supply side.

- (2.3)High Voltage: If charging voltage is over $3.65V$ per cell, battery protection will turn on. Solution: Check whether voltage is too high or not, if it is, to change the settings on power supply side. And discharge the battery.

- (2.4) Low Voltage: When the battery discharges to 2.75V/cell or less, battery protection will turn on.
Solution: Charge the battery till the red light turns off.
- (2.5) Cell voltage high.
Solution: keep charging or keep the system cycle.
The BMS can balance the cell during cycling.
- (3) Unable to charge and discharge with red LED on. The temperature is 0~50 degree. Use charger to charge, not possible. Use load to discharge, not possible.
- (3.1) Under permanent protection. The single cell voltage has been higher than 3.8 or lower than 2.0 or temperature higher than 80 degree.
Solution: Switch off the module and contact your local distributor for repair.
- (4) Unable to charge and discharge without red LED on. The temperature is 0~50 degree. Use charger to charge, not possible. Use load to discharge, not possible.
- (4.1) Fuse broken.
Solution: Switch off the module and contact your local distributor for repair.



Caution
Buzzers indicate high risk faulty condition

- (5) Buzzer rings.
- (5.1) Reverse connection of cables.
Solution: Power off all battery and inverters. Disconnect breaker. Check the cable connection and disconnect all power cables. Check the power port damaged or not. then try turn on the single module, without any cable connected. If no alarm, then it is reverse connection of cables.
Switch off the module and contact your local distributor.
- (5.2) MOSFAIL.
Solution: Power off all battery and inverters. Disconnect breaker. Check the cable connection and disconnect all power cables. Check the power port damaged or not.

then try turn on the single module, without any cable connected. If still buzzer rings. Then it is mosfail. Switch off the module and contact your local distributor.

(6) After switch On, the module turns on directly

(6.1) BMS failure.

Solution: Switch off the module and contact your local distributor.

Excluding the points above, if the faulty is still cannot be located, turn off battery and repair.

6. Emergency Situations

(1) Leaking Batteries

If the battery pack leaks electrolyte, avoid contact with the leaking liquid or gas. If one is exposed to the leaked substance, immediately perform the actions described below.

(1.1) Inhalation: Evacuate the contaminated area and seek medical attention.

(1.2) Contact with eyes: Rinse eyes with flowing water for 15 minutes and seek medical attention.

(1.3) Contact with skin: Wash the affected area thoroughly with soap and water and seek medical attention.

Ingestion: Induce vomiting and seek medical attention.

(2) Fire

NO WATER! Only dry powder fire or carbon dioxide extinguisher can be used; if possible, move the battery pack to a safe area before it catches fire.

(3) Wet Batteries

If the battery pack is wet or submerged in water, do not let people access it, and then contact Pylontech or an authorized dealer for technical support. Cut off all power switch on inverter side.

(4) Damaged Batteries

Damaged batteries are dangerous and must be handled with the utmost care. They are not fit for use and may pose a danger to people or property. If the battery pack seems to be damaged, pack it in its original container, and then return it to Pylontech or an authorized dealer.



Caution

Damaged batteries may leak electrolyte or produce flammable gas.

7. Remarks

Recycle and disposal

In case a battery (normal condition or damaged) needs disposal or needs recycling, it shall follow the local recycling regulation (i.e. Regulation (EC) N° 1013/2006 among European Union) to process, and using the best available techniques to achieve a relevant recycling efficiency.

Maintenance

- (1) It is required to charge the battery at least once every 6 months, for this charge maintenance make sure the SOC is charged to higher than 90%.
- (2) Every year after installation. The connection of power connector, grounding point, power cable and screw are suggested to be checked. Make sure there is no loose, no broken, no corrosion at connection point. Check the installation environment such as dust, water, insect etc. make sure it is suitable for IP54 battery system.
- (3) If the battery is stored for long time, it is required to charge them every six months, and the SOC should be higher than 90%.

